

UNIVERSITY *of* NEW HAMPSHIRE

**MICROFLANGING OF CUZN30
SPECIMENS USING
ELECTROMAGNETIC FORMING**

Reid VanBenthysen and Brad L. Kinsey
Mechanical Engineering Department
University of New Hampshire

Presentation Overview

- Background & Goals
- Quasi-Static Setup & Results
- EMF Setup & Results
- Quasi-Static & EMF Comparison
- Current Work
- Conclusions and Future Work



Inhaler with micronozzle
(*STEAG microParts*)

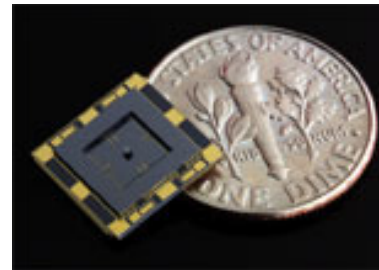

Microgyroscope
(*Boeing Satellite Systems*)

Background

- Several components incorporated in modern everyday products are decreasing in size. Items such as laptops, cell phones and PDA's require components with at least two dimensions in the sub millimeter range.
- Current means of fabricating microscale parts include:
 - IC processing techniques
 - Microscale machining
 - Microscale injection molding
 - Microscale forming



Micro Fuel Processor
(Pacific Northwest Lab)

Size Effects

- Due to their extremely small size, components formed at the microscale exhibit much different behavior than those formed at the macroscale (i.e., size effects).
 - Size Effects - variations in material properties, process parameters, deformation, etc. as the grain size approaches the specimen feature size (*Armstrong, J. Mech. Phys. Solids, 1961*)

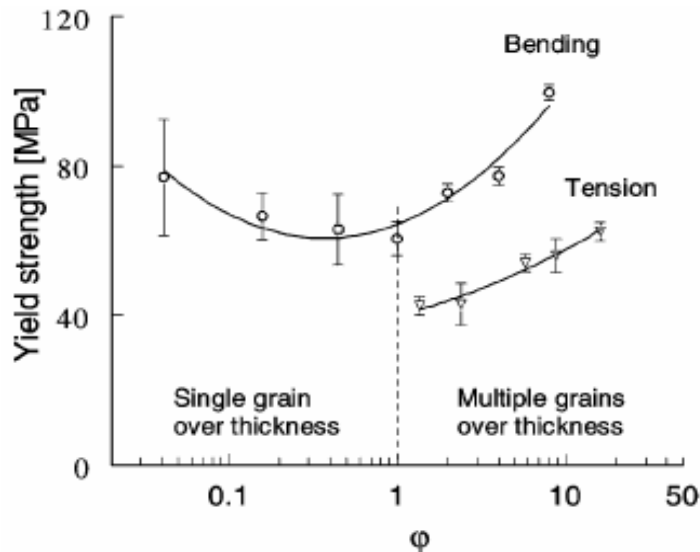

Effect of miniaturization on yield strength. *Raulea*

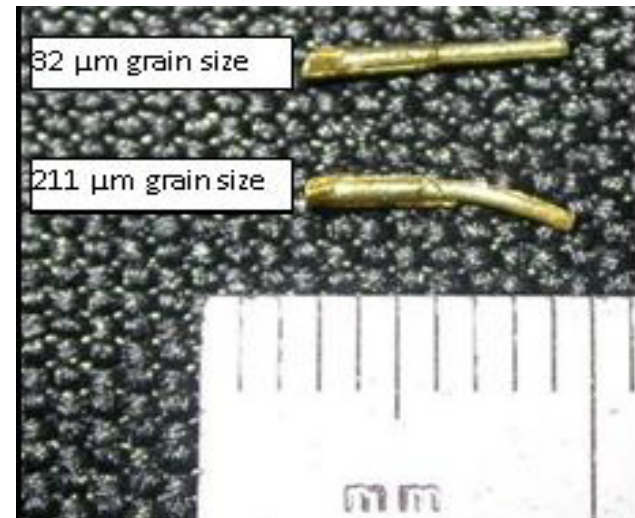

Size effects in micro-extruded pins –
0.76/0.57mm. *Parasiz*

Springback

- Due to their extremely small size, components formed at the microscale exhibit much different behavior than those formed at the macroscale.

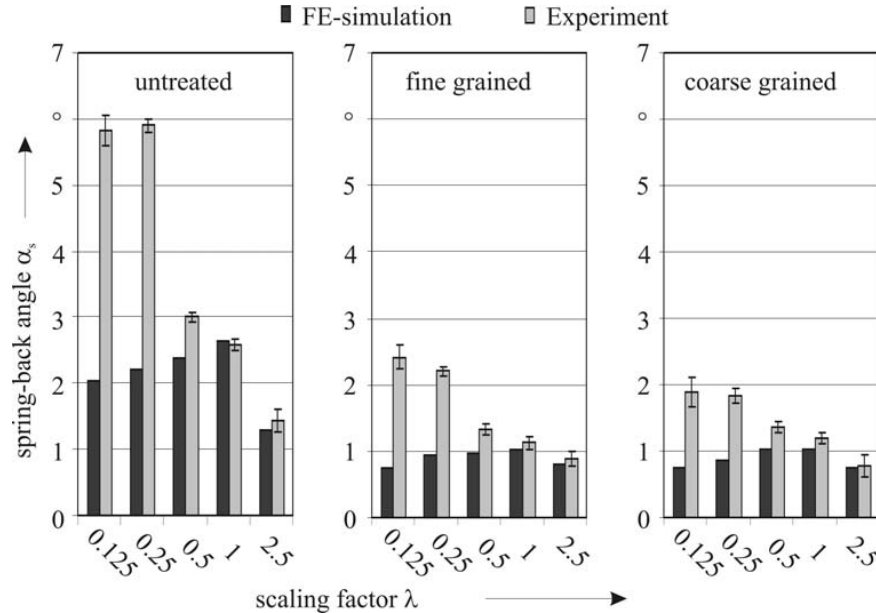

(Diehl et al., *Springback Behavior*, 2005)

- Figure shows springback angle versus the scaling factor λ for Al 99.5 specimens with a thickness of 200 μm ($\lambda = 1$)
- As the sample size decreases, the springback angle and data scatter increase
- This causes inconsistent final part geometries

Electromagnetic Microforming

- In electromagnetic (EM) forming, a charged capacitor banks is a quickly dissipated into a specially designed magnetic coil. Repulsive magnetic fields are produced in the coil and the workpiece; thus, the workpiece is launched at a high velocity away from the coil.
- EM forming has been shown to reduce springback and produce consistent part geometries.
- At the microscale, EM forming may be viable process due to the lower deformation forces and thus reduced energy requirements.

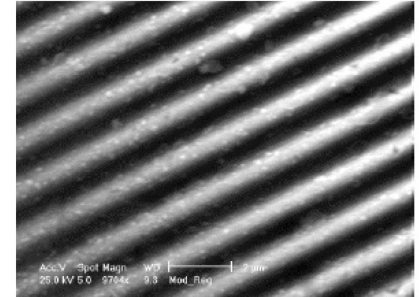
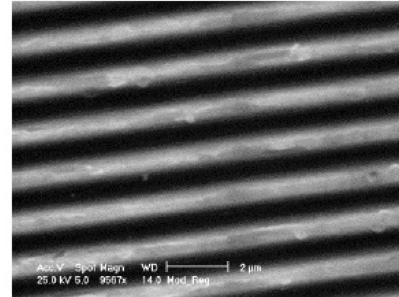
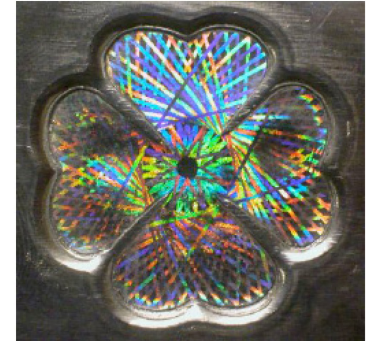
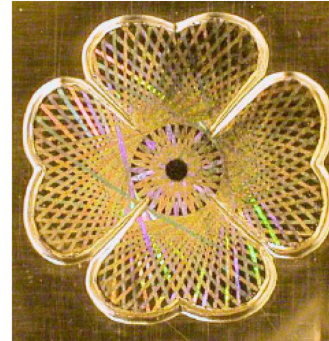

Embossing on copper (left, 2.4 kJ) and Aluminum (right, 4.0 kJ) of 100 x 75 mm area (*Daehn et al., ICOMM, 2006*)

Goals of Research

To investigate:

- If the increased springback and data scatter exhibited during microforming can be alleviated by using EMF.
- If the deformation induced during quasi-static and electromagnetic forming are different (e.g., the hardness distribution through the thickness of specimens)

Experimental Setup – Quasi-static

- Punch, die and process parameters are all functions of the specimen thickness.
- 0.127, 0.508 and 1.588mm thick CuZn30 specimens
- Heat treated to achieve 2 and 10 grains through thickness
- Specimen width of $10t$ to assure plane strain condition

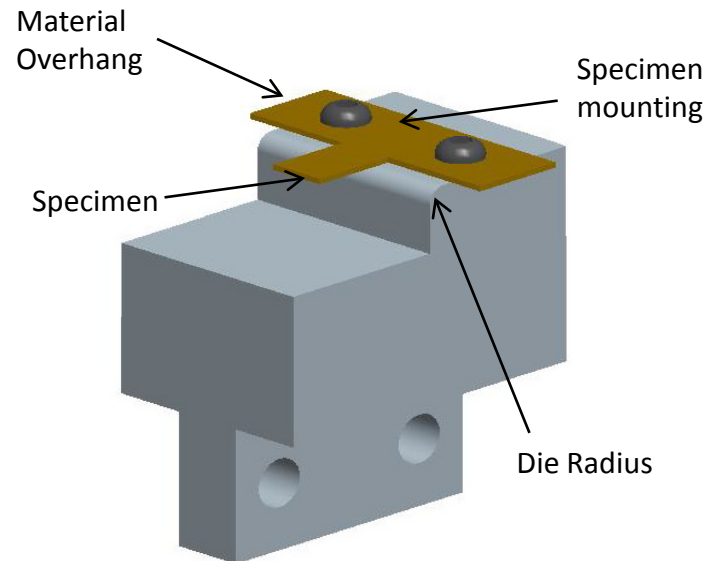
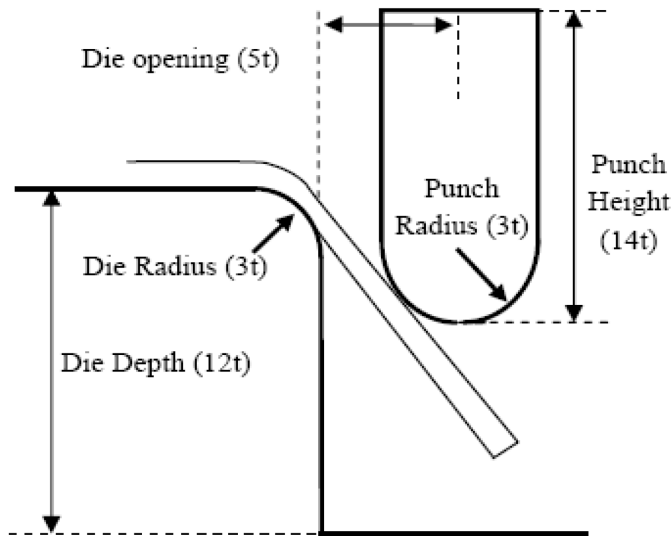

Quasi-static Springback Results

- Data for 0.508 mm specimens presented
- Pre and post bending digital images were obtained
- Using digital imaging software, photos were overlapped and the springback angle was measured
- An increase in springback angle with thinner specimens of the same number of grains through the thickness was observed

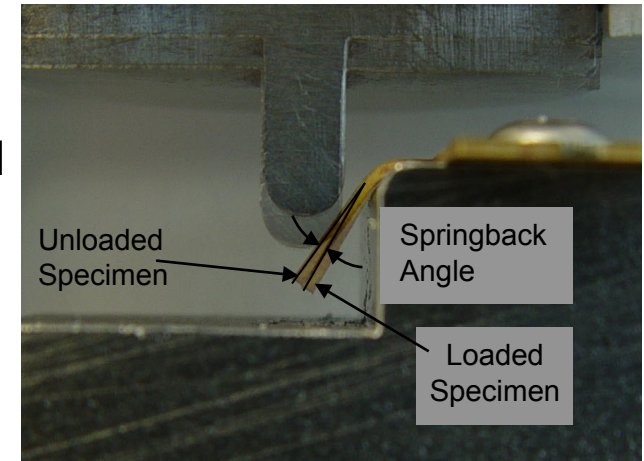

Measurement of springback angle

sample #	specimen size / # of grains through thickness					
	127 μm / 10	127 μm / 2	508 μm / 10	508 μm / 2	1588 μm / 10	1588 μm / 2
1	4.6	4	3.3	2.3	1.8	2.9
2	3.3	4.4	4.4	1.4	1.6	1.8
3	2.9	4.4	3.8	2	1.8	2.2
4	5.4	3.7	3	2.2	2.2	1.4
5	4.6	4.1	3.1	-	2.9	1.6
average	4.16	4.12	3.52	1.975	2.06	1.98

Electromagnetic Forming Setup

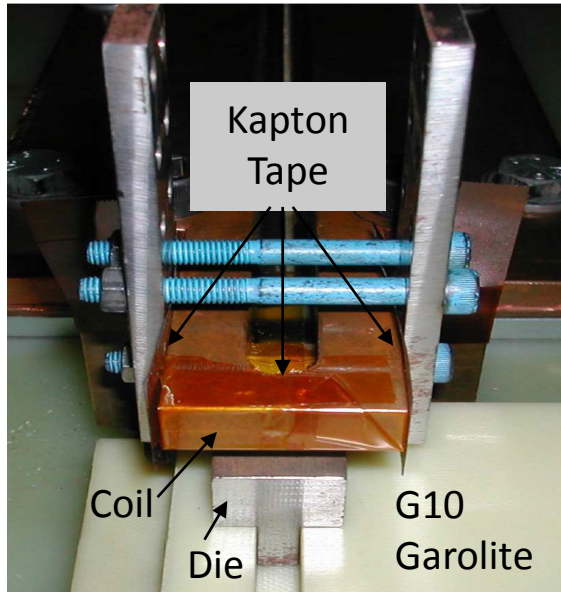

EMF experimental flanging setup

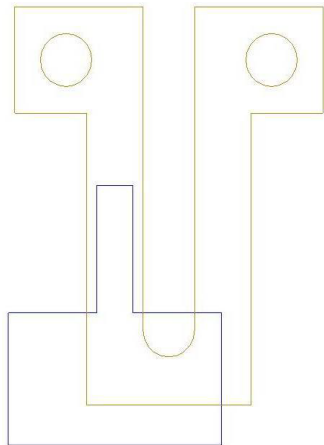

A top wireframe view of the coil and specimen strip

- The specimen is placed between the die and coil, and located under one coil leg
- The blue bolts prevent the leads of the coil from deforming as the experiment is conducted due to the repulsive force between the leads (i.e., legs of the coil).
- Kapton Tape is used to insulate the current from the rest of the frame/tooling.
- The die holder is fabricated from G10 Garolite, a strong and non-conductive material.
- Experiments were performed at Hirotec America, Inc.

EMF Results

- Specimens were flanged with power levels ranging from 1.7 to 8.4 kJ
- 0.127 mm specimens required a driver material (thicker sheet of material overtop of the thinner sheet which is also deformed during the process) to achieve flanging
- 1.588 mm specimens were not flanged due to the non uniform bending caused by the coil width being less than the specimen width
- Nearly complete right angle flanging was obtained for certain 0.508 mm specimens

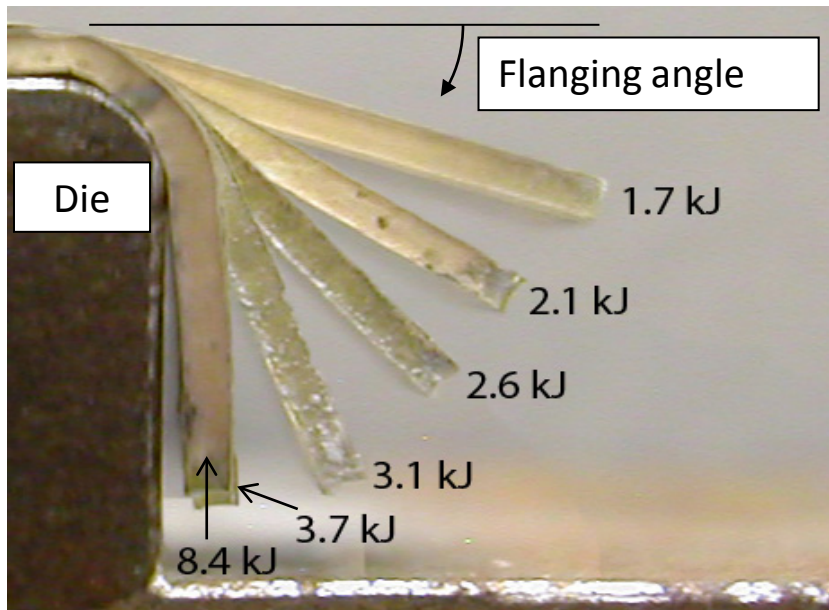

The effect of input energy on the flanging angle

- Digital imaging software was used to superimpose images as well as measure the flange angle
- Power levels ranging from 3.7kJ through 8.4kJ all achieved of nearly complete right angle flanging
- Specimens of 3.1 kJ, of matching flanging angle to the Quasi-static process, and 3.7kJ, of near complete right angle flanging were evaluated

Deformation Distribution

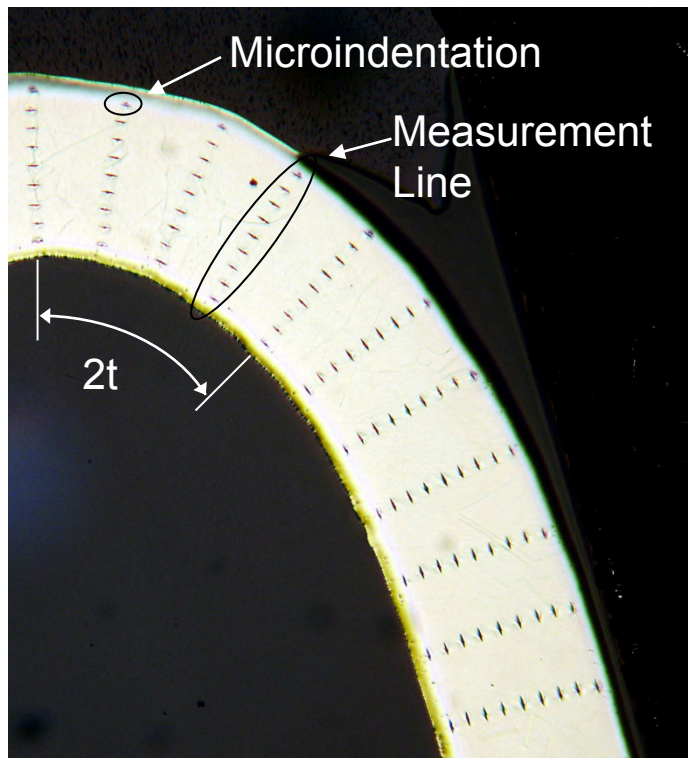

- To investigate the deformation distribution, microhardness measurements were performed through the thickness and along the length of the specimens.
- A Knoop indenter with a 10 gram load was used for the hardness measurements.

EMF and Quasi-static Comparison

Quasistatic - 10 grains through thickness

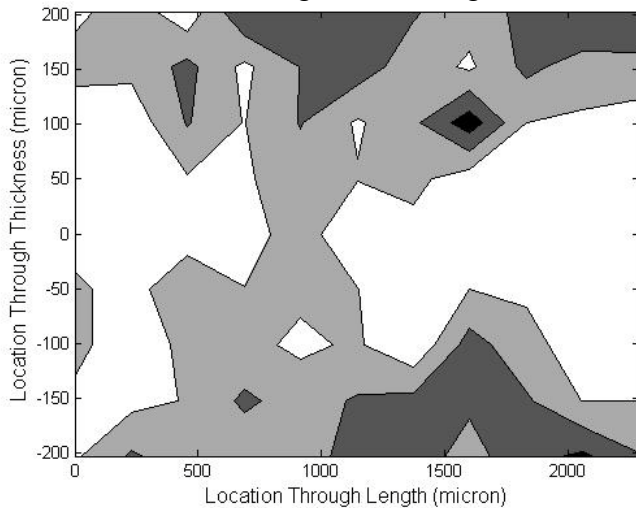

- Pattern of lower center hardness and higher edge hardness, i.e. tension & compression
- Change in hardness (HK) – center to edge

Grains/thickness	Quasi-static	3.1kJ - EMF	3.7kJ - EMF
2	17.4	16.6	16.6
10	22.1	20.0	23.8

3.1kJ - 10 grains through thickness

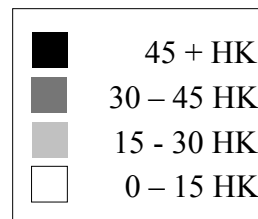
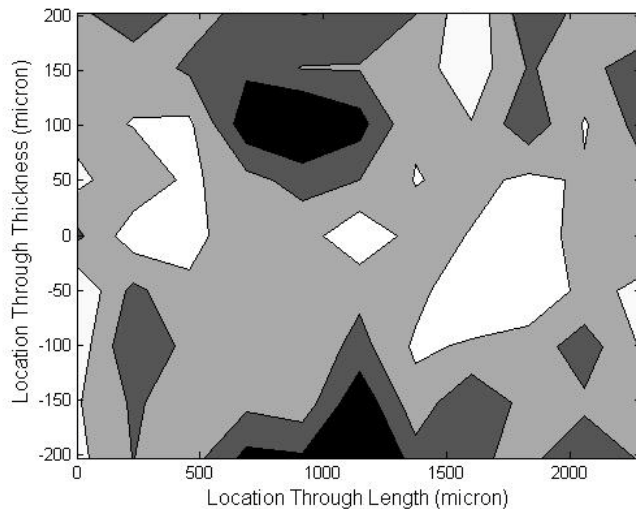

3.7kJ - 10 grains through thickness

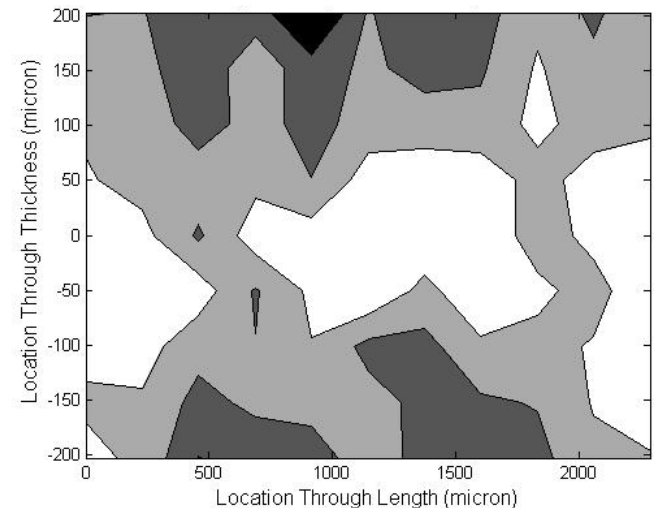

EMF and Quasi-static Comparison

- No change in hardness is observed between quasistatic and EM flanged specimens.
- Rough layered pattern of higher edge hardness with lower center hardness is due to only one set of measurements being taken, i.e. no averaging.
- Near complete flanging case (3.7kJ) demonstrates more of a layered pattern due to higher strain from further deformation

Coil Design Simulations

- Magneform JA7000 12kJ machine acquired for further EM flanging
- A new coil has been designed to facilitate uniform flanging of the 1.588mm thickness specimen
- MagNet, an electromagnetic field simulation package by Infolytica Corp., has been used.
- Cu101 material is used
- Current of 146kA used due to assumed rise time.
- 4 Different models; rectangular, inward taper, outward taper and semicircular



Non uniform flanging of 1.588mm specimen

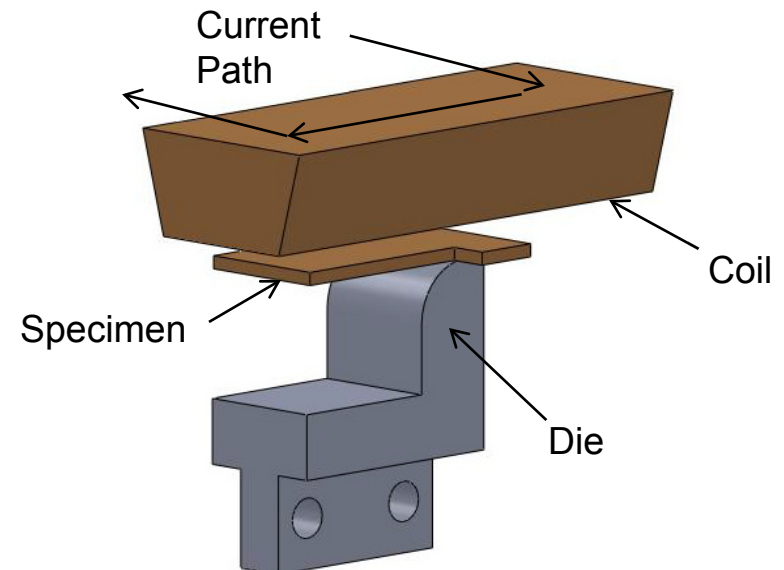

Coil and die/specimen setup

Coil Design Simulations

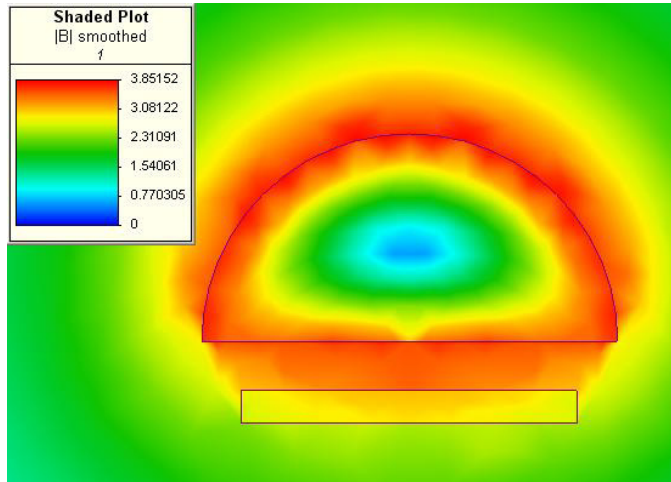

Semicircular

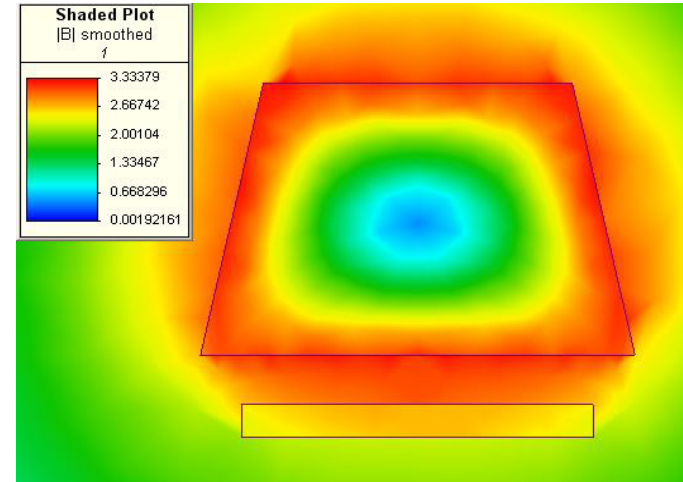

Inward taper

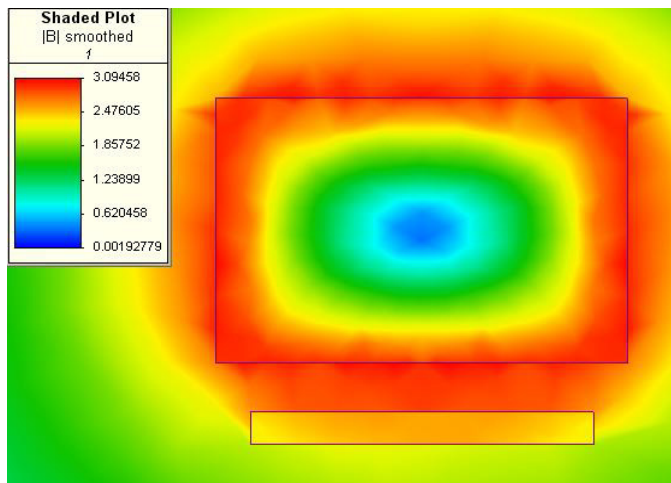

Rectangular

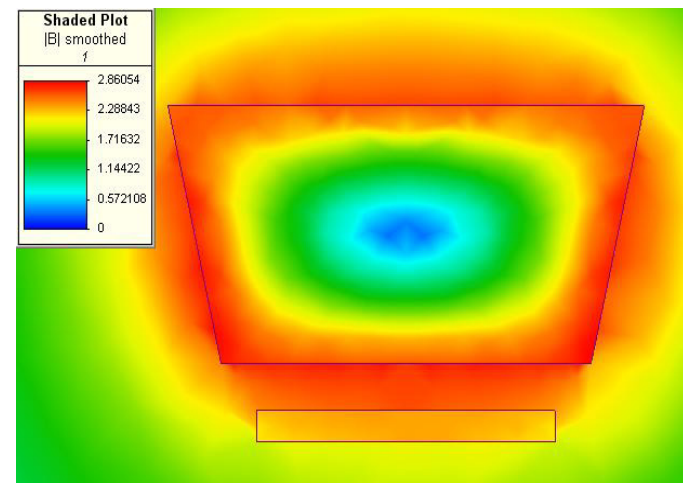

Outward taper

Coil Design Simulations

- Line plots of the magnetic field (B) were created for two different paths
 - X plot, 2mm below the bottom coil face, covers the specimen width
 - Y plot, at the vertical midplane (X=0), covers the bottom coil face through the specimen.

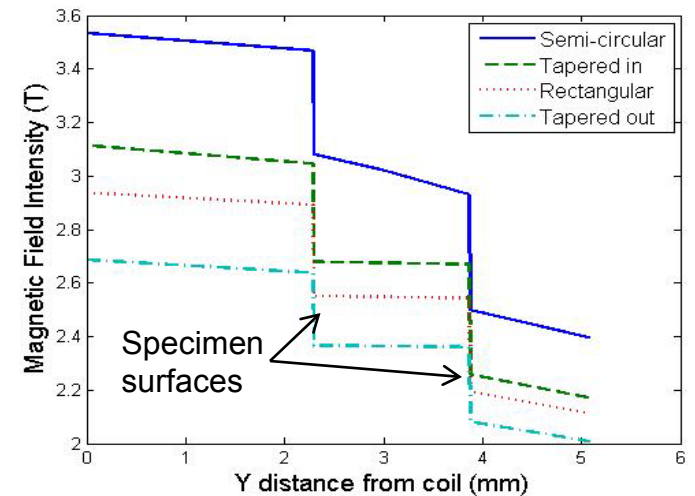
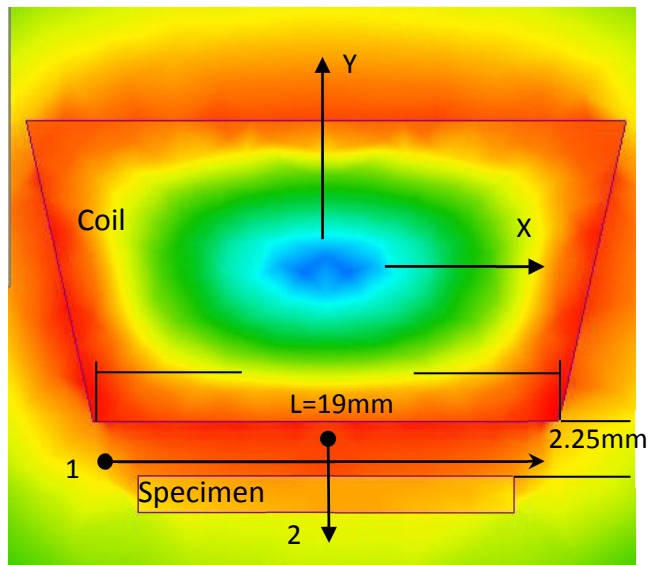
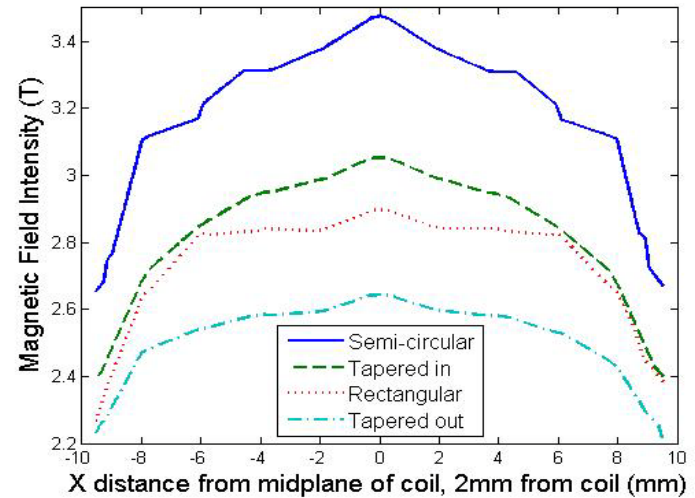

Coil Design Simulations

- An Increase in magnetic field is associated with a decrease in cross sectional area, i.e. an increased current density
- Lower values of B correlate to a more uniform magnetic field across the width of the specimen
- As previous experiments with 1.588mm specimen and horse shoe shaped coil yielded non uniform flanging, the coil with an outward taper was chosen since it provides the most uniform magnetic field across the specimen width.

Conclusions and Future Work

- Based on initial hardness measurements through the cross-section of specimens, it appears that the deformation in both processes are similar.
 - The EMF process was able to achieve a complete right angle flanging for energy levels greater than 3.7 kJ.
 - The springback angle in the quasi-static process showed increasing springback with miniaturization, consistent with past research results.
 - A new coil design for flanging 1.588mm specimens was chosen.
-
- Conduct further experiments in order to:
 - Obtain hardness contour plots that are the average of several measurements
 - Investigate springback and data scatter in both quasi-static and EMF processes
 - Investigate more effective methods to EM flange the 0.127mm specimens without use of a driver material



Acknowledgments

- Funding from the U.S. National Science Foundation (CMMI-0644705) is gratefully acknowledged.
- Hirotec Inc.

References

Brush Wellman, “Elastic Springback”, May 2000.

A. Diehl, U. Engel, M. Geiger, “Investigation of the spring-back behavior in metal foil forming”, 2005.

Parasiz, M, Kinsey, B. “Deformation Size Effects Due to Specimen and Grain Size in Microbending”, Vol. 132, 2010, in press.

Raulea, L.V., Goijaerts, A.M., Govaert, L.E., Baaijens, F.P.T., “Size effects in the processing of thin metal sheets”, *Journal of Materials Processing Technology*, 115, 2001, 44-48.

Impulse-Based Metal Forming, Daehn, Ohio State University, <http://mse-gsd1.matsceng.ohio-state.edu/~glenn/hyperplasticity/Hyperplasticity%20Main%20Page.html>.

Kamal, M., “A Uniform Pressure Electromagnetic Actuator For Forming Flat Sheets”, Ohio State University Dissertation, September 2005.

Kamal, M., V.Cheng, T.K. Sue, J. Shang and G.S. Daehn, “Replication of Microfeatures by Electromagnetic Launch and Impact”, *Proceedings of ICOMM*, 2006, 197-202.



Questions?